

SARAY®

Aluminium Cotta Design

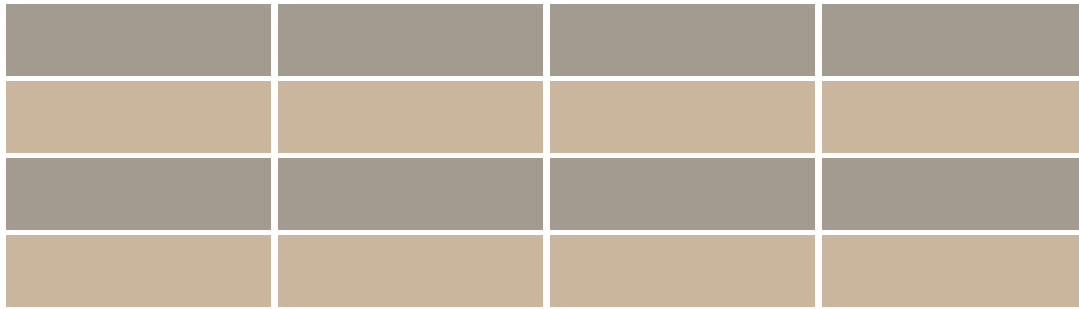

COLORS

New Collection

Aluminium Linear Design

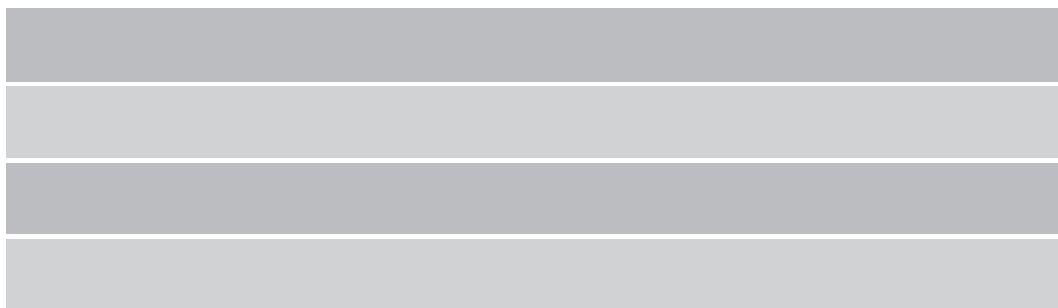

SARAY[®] | Mimari Sistemler
Architectural Systems

Mükemmel yapılar için...

SARAY®

Hakkımızda / About Us



MÜKEMMEL YAPILAR İÇİN...

35 yılı aşkın tecrübesiyle, **Saray Alüminyum** Türkiye alüminyum sektörünün önde gelen firmalarındandır. Modernize edilmiş entegre tesisleriyle, İstanbul Güneşli ve Tekirdağ Çerkezköy' de, toplam 90.000 m² kapalı alanda Endüstriyel Profiller, Alüminyum Mimari Sistemleri, Alüminyum Kompozit Panel ve PVC Profil üretimleri yapmaktadır.

İlk 250 sanayi şirketleri içerisinde yer alan ve alüminyum sektöründe ihracat birincilikleri olan **Saray Alüminyum** endüstriyel ve mimari çözümlerinin %55'den fazlasını; Avrupa, Afrika, Asya ve Orta Doğu bölgelerinde 60'dan fazla ülkeye ihraç etmektedir.

Saray Alüminyum Toplam Kalite Yöntemi kullanır; firmamızın ISO 9001, ISO 14001, ISO 50001, CE, Qualicoat, Qualanod sertifikaları ve ürünlerinin TSE, TSEK, TS – EN, IFT – Rosenheim, GOST-R, UKR-S, MPA Dresden, Aplus, Uluslararası Teknik Onay, G Uyumluluk Belgesi ve çevre dostu bir firma olarak "Çevresel Ürün Beyanı - Environmental Product Declaration (EPD)" gibi sertifika ve onayları bulunmaktadır.

FOR ELEGANT BUILDINGS

*With over 35 years' experience in aluminium industry, **SARAY Aluminium** is one of the leading company in Turkey. With the modernized & fully integrated plants in Gunesli (Istanbul) and Cerkezkoy (Tekirdag), **SARAY Aluminium** produce Industrial Aluminium Profile, Aluminium Door and Window Systems, Curtain Wall System and Aluminium Composite Panel product groups in 90.000 sqm closed area.*

*As one of the Top 250 ranked industrial companies & export leading company in aluminium industry, **SARAY Aluminium** is exporting more than 55% of its Industrial & Architectural Solutions to more than 60 countries in Europe, Africa, Asia and Middle East regions.*

SARAY Aluminium utilizes Total Quality Management, the company has been certified to ISO 9001, ISO 14001, ISO 50001, CE, Qualicoat, Qualanod and its wide range of production has been certified by TSE, TSEK, by TS-EN, IFT-Rosenheim, GOST-R, UKR-S, MPA Dresden, Aplus, UTO/ITA, G Conformity and as an eco-friendly company it has Environmental Product Declaration (EPD)

SARAY®

COTTA DESIGN

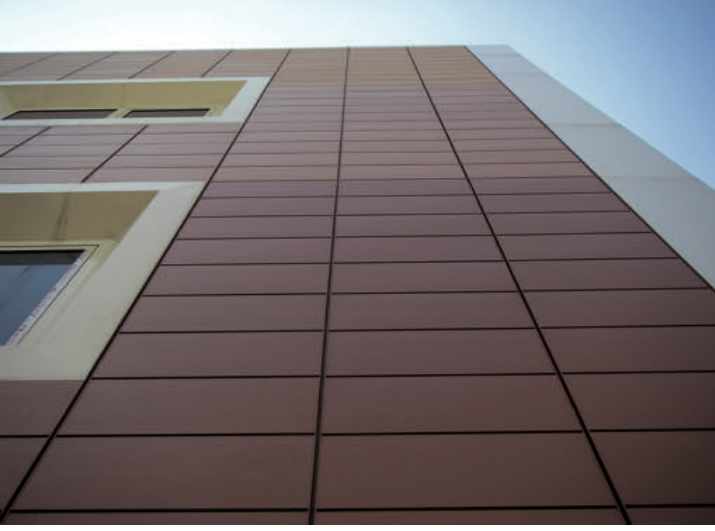

Dünya'da ilk Tuğla Görünümlü Alüminyum Cephe Kaplama Sistemi

Patent No: 2008 / 01925

*The First In The World !
Ceramic Tile or Brick Look Aluminium Facade Systems*

Patent No: 2008 / 01925

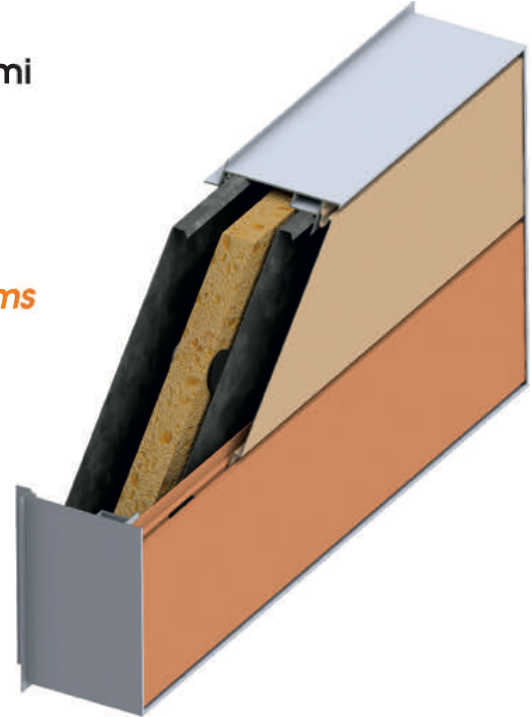
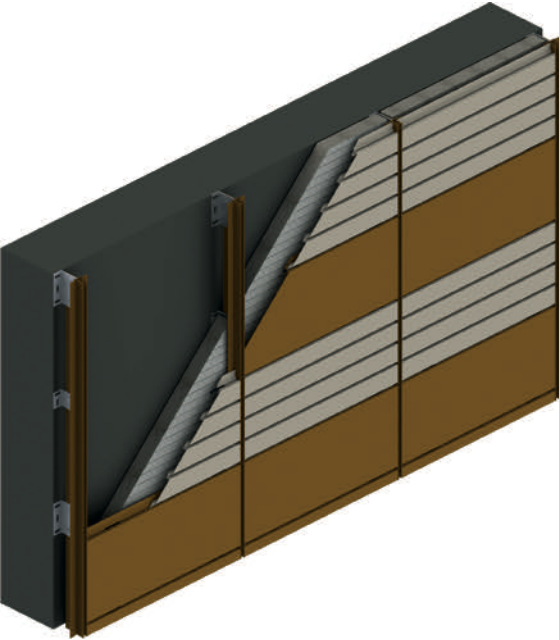

SARAY COTTA ile
cephenizin boyası, uzun yıllar boyunca
Uluslararası QUALICOAT Garantisi altındadır.

*With SARAY COTTA,
coating of your facade is under warranty of
international QUALICOAT certificate for many years*

Yeni nesil cephe kaplaması SARAY COTTA DİZAYN

SARAY COTTA DİZAYN ile cephe kaplamak; pişmiş kil malzemelere göre işçilik, zaman ve maliyet açısından büyük avantaj sağlamaktadır. Ekonomiktir ve montajı kolaydır.

SARAY COTTA DİZAYN 8 kg/m² ortalama montaj yoğunluğu ile yapının statik mukavemetine destek olur.

Qualicoat boya teknolojisi ile üretilen SARAY COTTA DİZAYN kirlenmez, solmaz ve yıpranmaz. Uzun ömürlüdür.

SARAY COTTA DİZAYN profiller alüminyum ekstrüzyon ürünü olduğundan; yangın emniyetlidir. Çevre dostudur.

SARAY COTTA DİZAYN pişmiş kil türevi bir malzeme olmadığından; mimari proje ve cephenin durumuna göre istenilen boyutta üretilme imkanına sahiptir.

Özel projelerde, standart renk kartelası dışında istenilen renkte SARAY COTTA DİZAYN üretilebilir.

SARAY COTTA DİZAYN, yangın dayanımı olarak, A2 Yanmazlık Sınıfında olup bu özelliği ile tüm binalarda tercih sebebi olmaktadır.

SARAY Mimari Sistemler, gelişmiş AR-GE departmanı ve sahip olduğu ileri teknolojiyle her türlü mimari yapıya çözüm sunmayı hedefler, tasarladığı her yeni ürün mimari bir değerdir. Üründe ve hizmette tam kalite anlayışıyla en iyisini sunmak için çalışır

New generation material for facade SARAY COTTA DESIGN

In comparison to ceramic tile cladding, SARAY COTTA DESIGN has an advantage on labor cost, and time

With approximately 8 KGs of aluminium used per 1m², SARAY COTTA DESIGN increases the static strength of the structure

Coating with QUALICOAT technology, SARAY COTTA DESIGN is dirt-repellent, nonfading and ageless.

As an extruded profile, SARAY COTTA DESIGN is fire resistant and eco-friendly product.

Since it's not a baked clay product, SARAY COTTA DESIGN can be produced in requested dimension according to the architectural structure and facade.

In addition to the standard color chart, SARAY COTTA DESIGN can be coated with desired color for special projects.

SARAY COTTA DESIGN is an A2 degree of incombustible material, thus it's preferred in any kind of buildings.

SARAY Architectural Systems aims to offer solutions to all architectures with it's advanced R&D department and hi-tech production, all the new designs & solutions are architectural value. It works to offer the best product and service with total quality management.

SARAY®

LINEAR DESIGN



Saray Linear Design ile cephenizin kaplaması istediğiniz renk ve istediğiniz uzunluktadır.

Uluslararası A2 Yanmazlık Garantisi altındadır.

With SARAY Linear Design, cladding can be done with desired color and length.

It's under warranty of international A2 standards

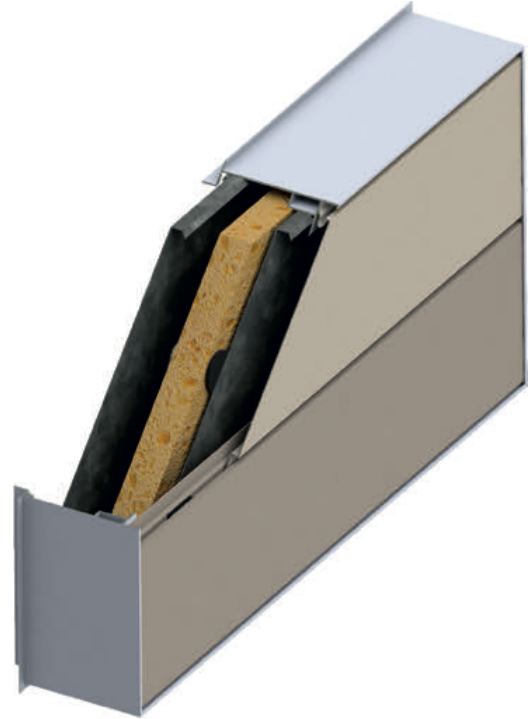

Pratik ve Hızlı Uygulanabilen
Alüminyum Cephe Kaplama Sistemi

*Quick and Easy Assembly
Aluminium Cladding System*

Yeni nesil cephe kaplaması SARAY SIDING

Alternatif soğuk ve kör cepheler için cephe kaplama malzemesidir. Ekonomik olduğu kadar da estetikdir. Profiller projeye göre istenilen uzunlukta ve renkte uygulanabilir.

Bu kartela da ki renkler en çok tercih edilen Linear Dizayn renkleridir. Arzu edildiği takdirde istenilen renkte de boyanabilir. Cotta Dizayn' dan farkı düşey profil olmamasıdır.

Linear Dizayn profilleri arkadan esnememesi için gizli olarak desteklenir ve sürekli linear bir görüntü elde edilir. Projeye göre yatay ya da dikey olarak uygulanabilir.

Cepheler Saray Linear Dizayn ile hem estetik hem de ekonomik olarak çözümlenir.

Saray Linear Dizayn, hızlı uygulanabildiğinden dolayı mimarların ve müteahhitlerin kurtarıcısıdır. Sistemin diğer bir özelliği de kolayca şantiyede uygulanabilmesidir.

PVC esaslı Siding malzemelere göre Alüminyumun A2 sınıfı yanmaz özelliğinin olması, renginin solmaması, istenilen renkte üretilebiliyor olması Saray Linear Dizayn' ı tercih edilebilir hale getirmiştir.

SARAY SIDING - New Generation Cladding

It's an alternative cladding material for cold and blind spots of the facade. It's aesthetic and economic. Profiles can be installed in desired color and length.

The colors in this catalogue is the most preferred Linear Design colors. It can be coated in desired color. The difference from Cotta Design is that Linear Design doesn't have vertical profiles.

In order to avoid stretching on the back, it has a hidden support and continuous linear view. Depending on the project, it can be installed horizontally or vertically.

With Saray Linear Design, facades have aesthetic and economic solutions.

Thanks to it's fast installation method, it saves time of the architects and contractors. Another specialty of this system is, it can processed and installed at the construction yard.

Being an A2 degree of incombustible material, having unlimited color options, not fading of the color makes Saray Linear Desing preferred in comparison to PVC based Siding materials.



C 622



C 625

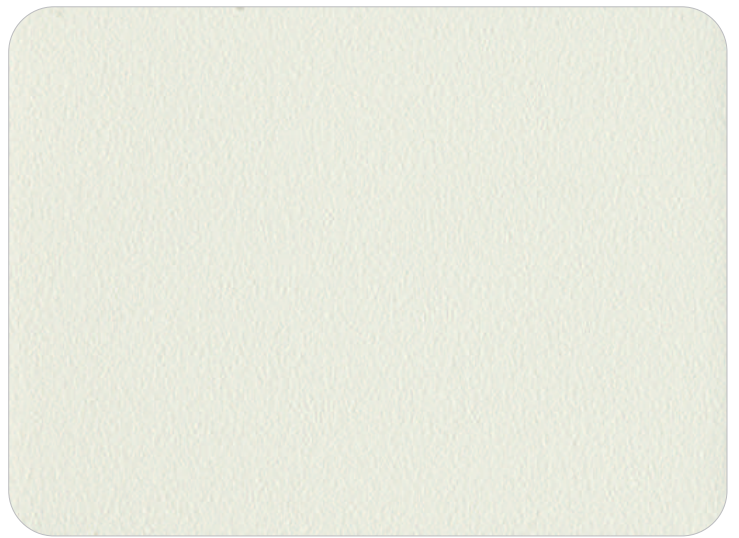

C 616

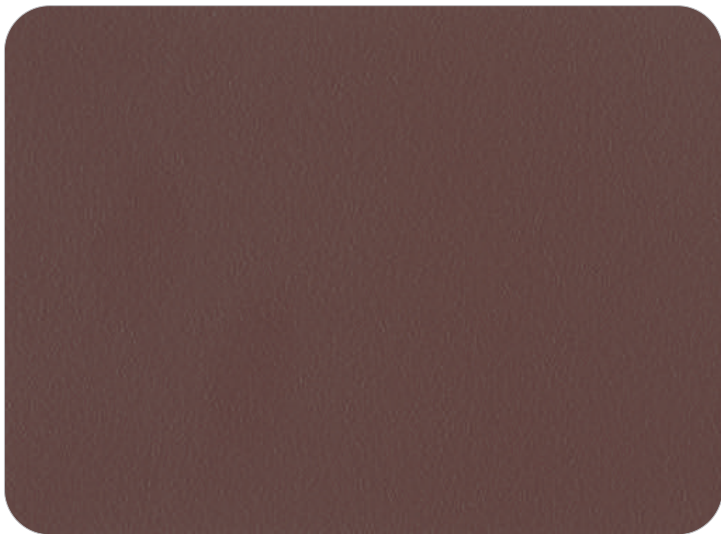

C 620



C 617

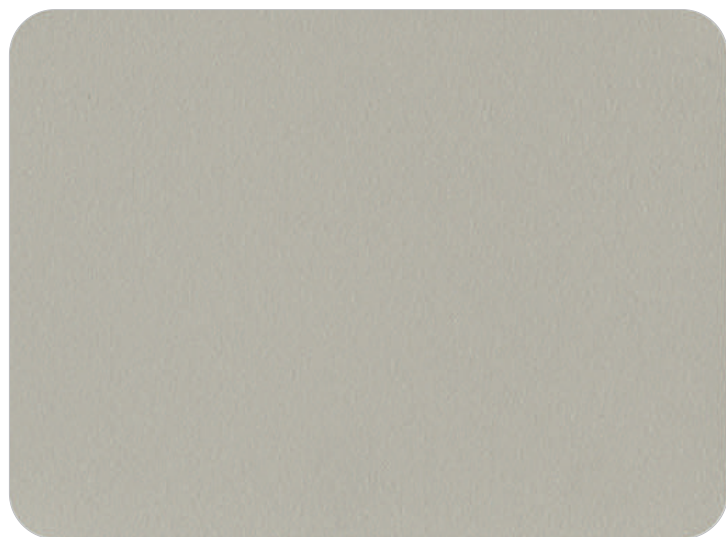

C 935

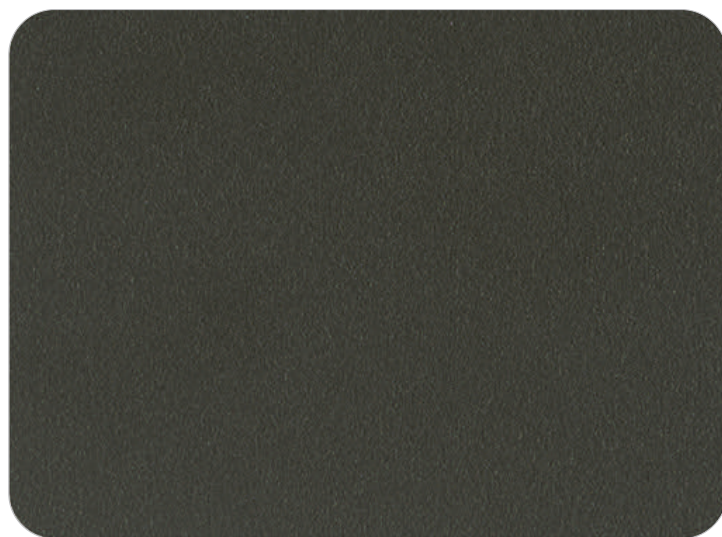

C 913

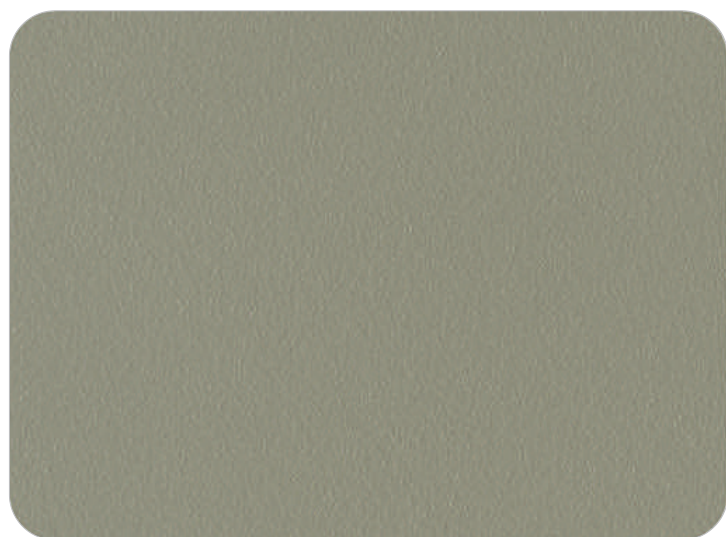

C 967

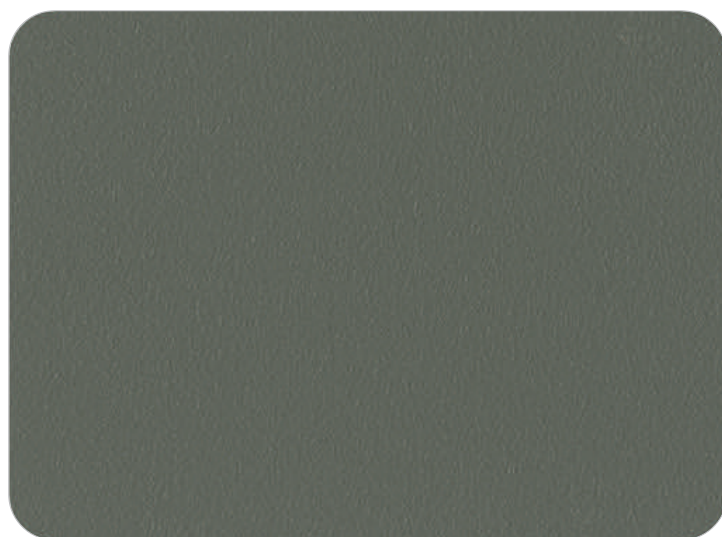

C 939

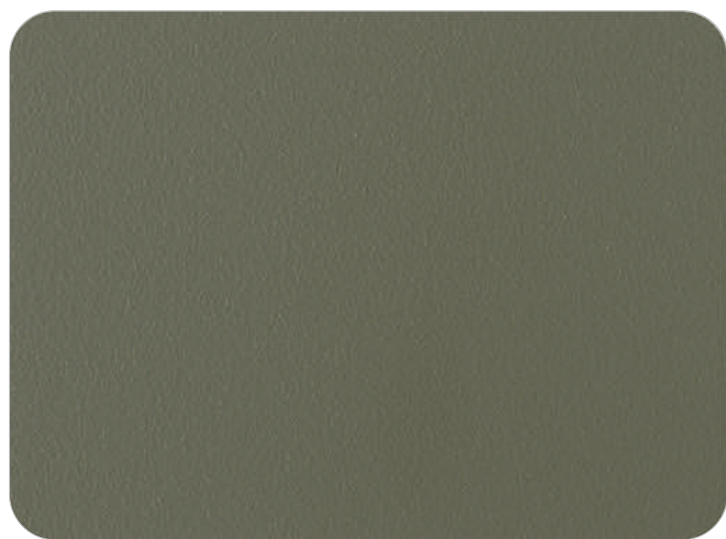

C 906





Akça Ağaç / Maple M 9410

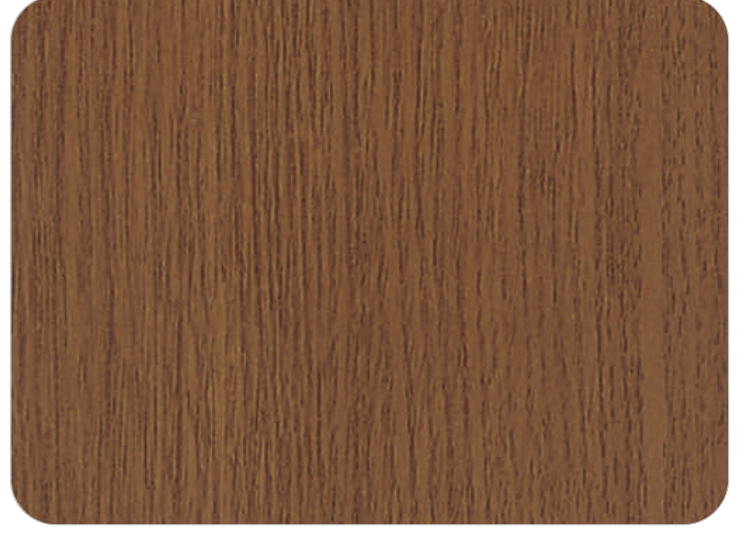

Açık Ceviz / Light Walnut M 9310



Koyu Meşe / Dark Oak M 9446



Koyu Ceviz / Dark Walnut M 7163



Kiraz / Chery M 9405



Açık Venge / Light Wenge M 9396



Afromozya Tik / Afromozya Teak 93093

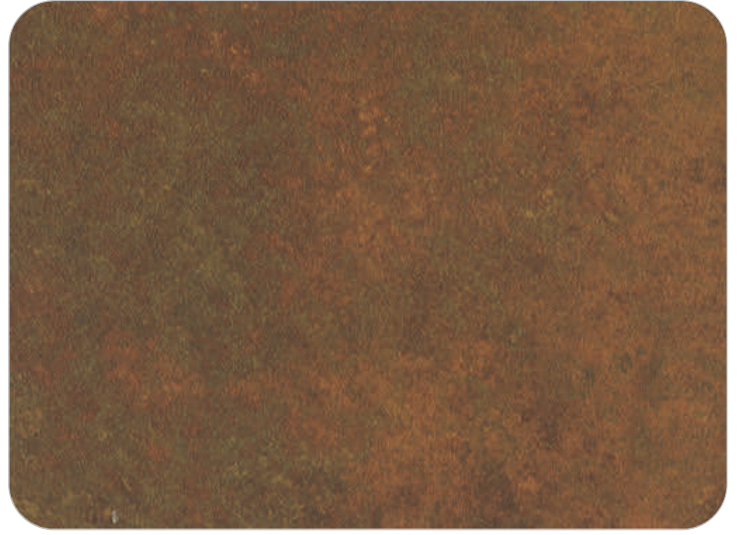

Corten 93092



Altın Meşe / Gold Oak 5131

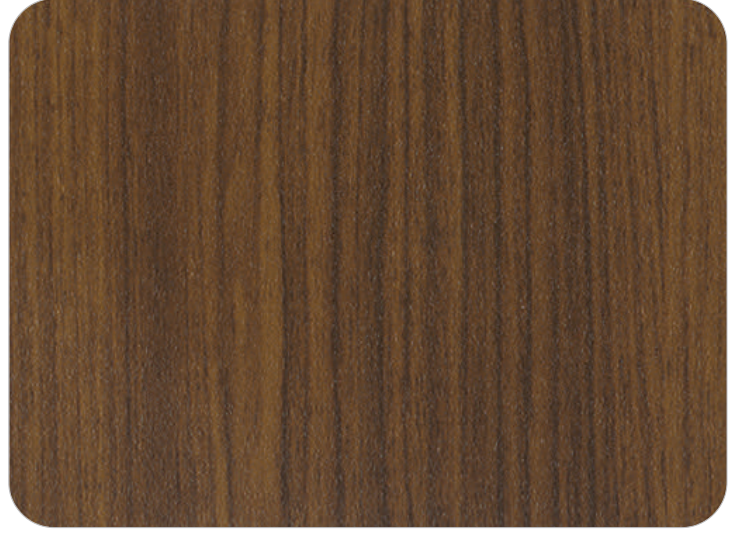

Tik / Teak 3181



Meşe / Oak 9111



Linear Dizayn / Linear Design

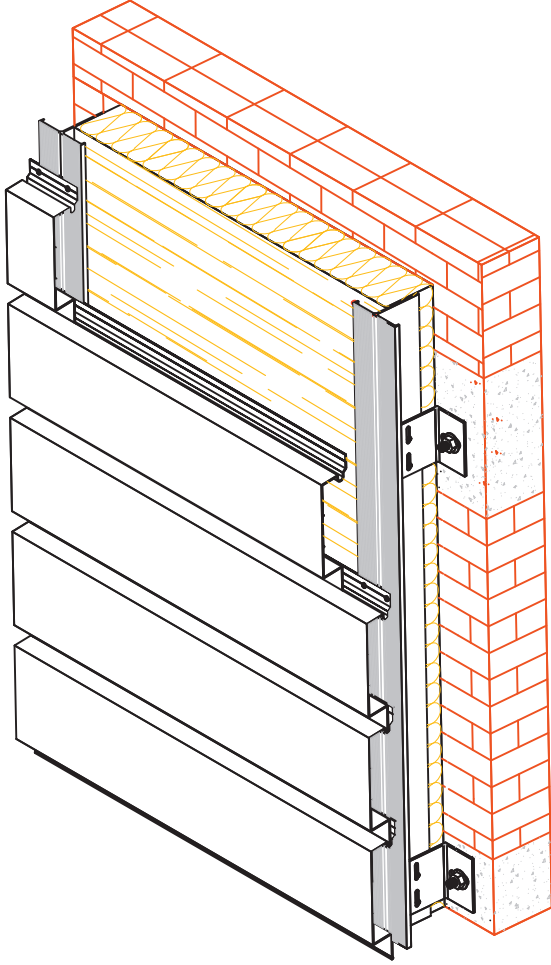

Cotta Dizayn / Cotta Design

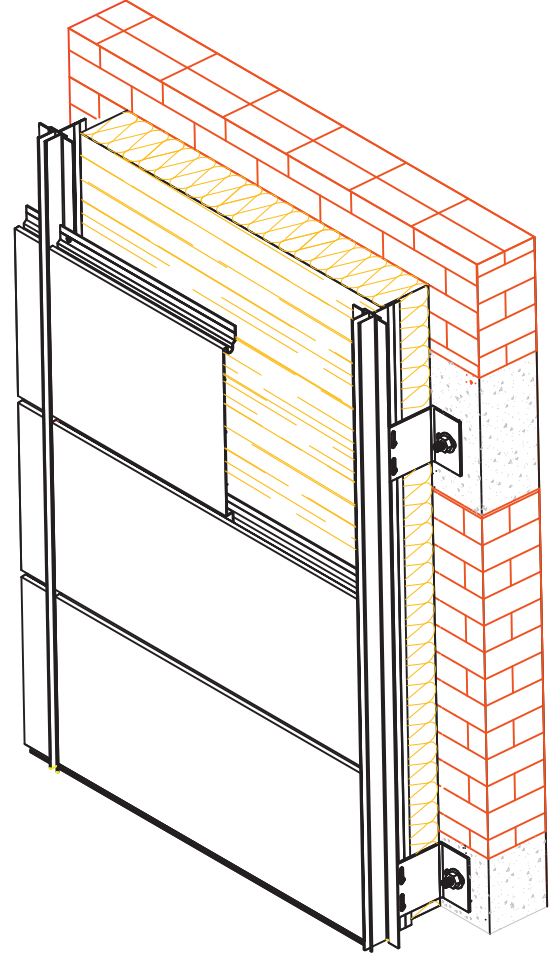

Profiller / Profiles

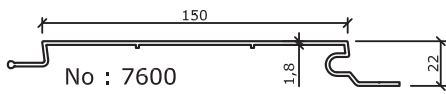

No : 7600
150' lik Cotta Lambri
1,180 kg/m

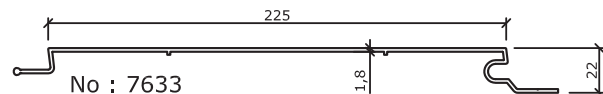

No : 7633
225' lik Cotta Lambri
1,545 kg/m

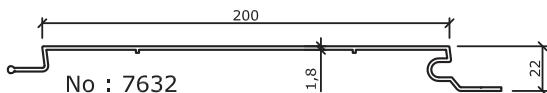

No : 7632
200' lik Cotta Lambri
1,420 kg/m

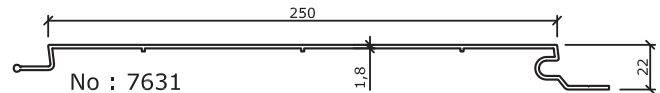

No : 7631
250' lik Cotta Lambri
1,670 kg/m

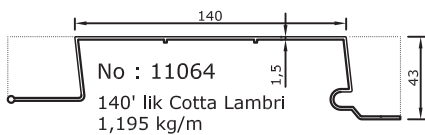

No : 11064
140' lik Cotta Lambri
1,195 kg/m

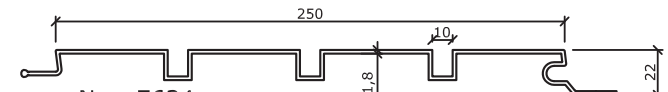

No : 7634
250' lik Fugalı Cotta Lambri
1,965 kg/m

Carrier T Profile

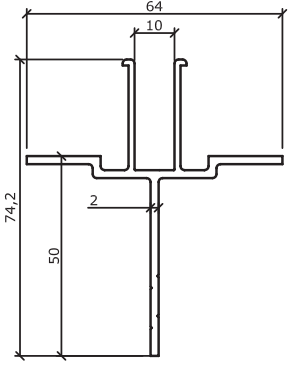

No : 7601

Taşıyıcı Profili
Jx = 8,92 cm⁴
Jy = 4,97 cm⁴
0,870 kg/m

Carrier Profile

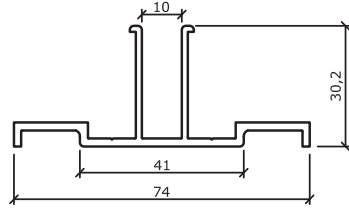

No : 7857

Taşıyıcı Profili
0,730 kg/m

Out Angle Corner Profile

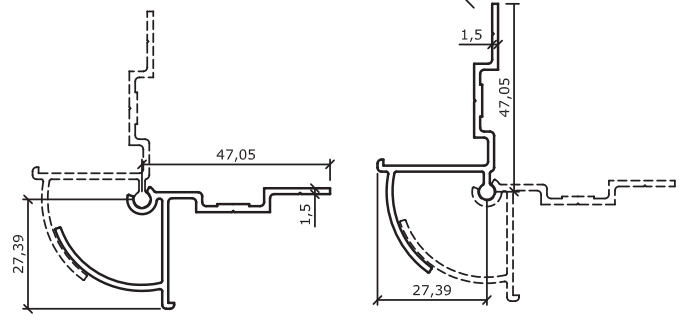

No : 7635

Açılı Dönüş Profili
0,535 kg/m

No : 7636

Açılı Dönüş Profili
0,505 kg/m

Bottom Finishing Profile

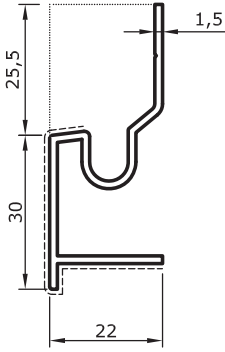

No : 7645

Alt Bitiş Profili
0,450 kg/m

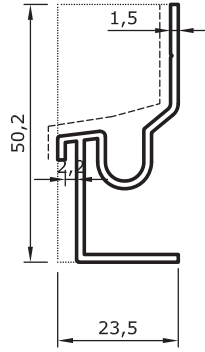

*No : 12192

Alt Bitiş Profili
0,430 kg/m

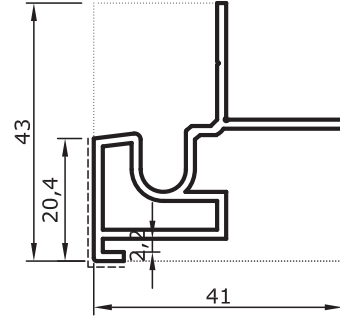

*No : 12193

90° Alt Bitiş Profili
0,545 kg/m

L Support Carrier Profile

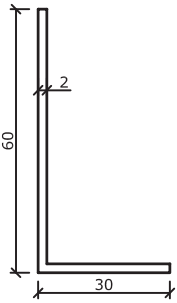

No : 1306

L Destek Taşıyıcı Profili
0,480 kg/m
Jx = 7,27 cm⁴
Jy = 0,77 cm⁴

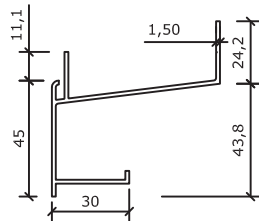

No : 8269

Üst Bitiş Profili
0,750 kg/m

In Angle Corner Profile

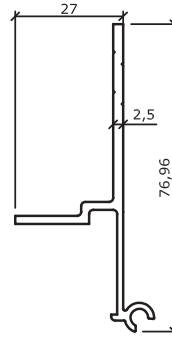

No : 7774

Köşe Dönüş Profili
(iç köşe)
0,650 kg/m

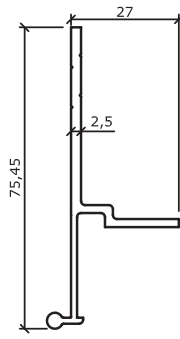

No : 7775

Köşe Dönüş Profili
(iç köşe)
0,635 kg/m

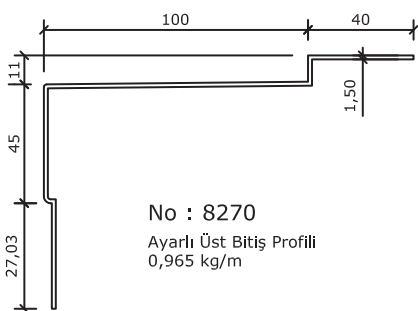

No : 8270

Ayarlı Üst Bitiş Profili
0,965 kg/m

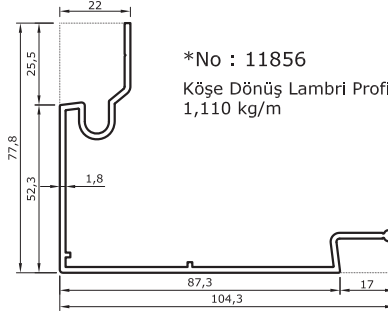

*No : 11856

Köşe Dönüş Lambri Profili
1,110 kg/m

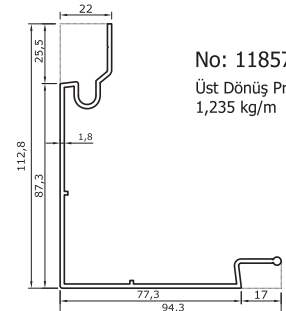

No: 11857

Üst Dönüş Profili
1,235 kg/m

Analiz Tablosu

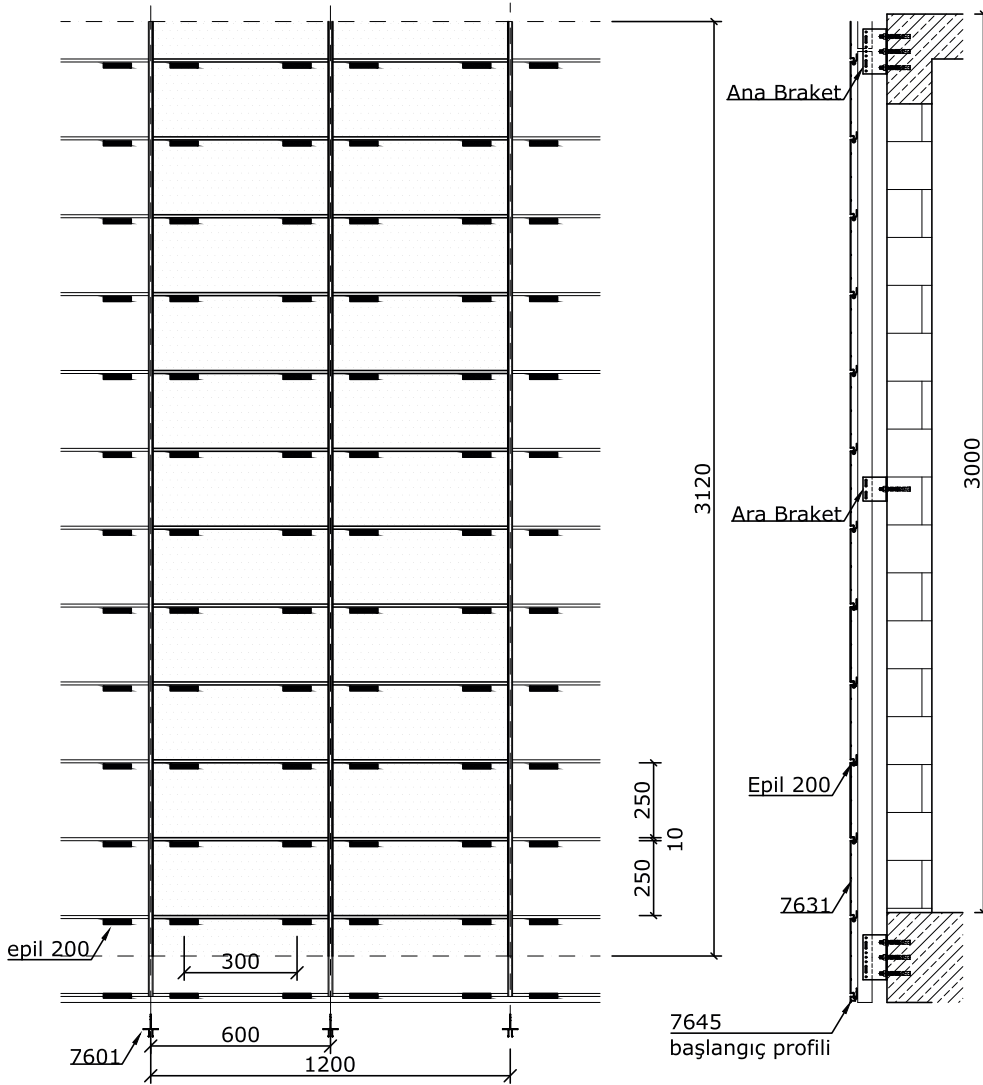

Aksesuar, Braketler

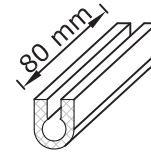

Epil 200
EPDM
U Fitil
(300 m ara ile kullanılır.)
U Gasket

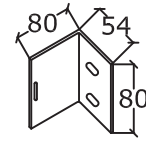

SC-526-80
Alüminyum
L Ara Braket 80/80
L Bracket 80/80

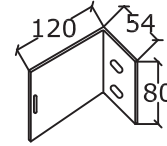

SC-527-80
Alüminyum
L Ara Braket 120/80
L Bracket 120/80

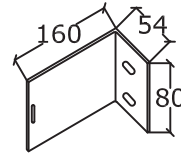

SC-528-80
Alüminyum
L Ara Braket 160/80
L Bracket 160/80

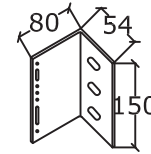

SC-526-150
Alüminyum
L Ana Braket 80/150
L Bracket 80/150

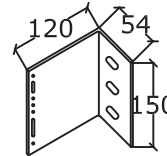

SC-527-150
Alüminyum
L Ana Braket 120/150
L Bracket 120/150

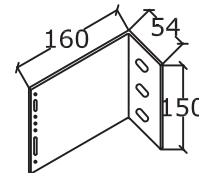

SC-528-150
Alüminyum
L Ana Braket 160/150
L Bracket 160/150

SARAYCOTTA ANALİZ ÖRNEĞİ

(1,20mx3,12m=3,744 m² için) (1m²=7,72 kg)

Malzemenin Cinsi	Birim	Miktar	Toplam
7601 Dikme profili	0,870 kg/m	6,240 m (3,12 m x 2 ad)	5,43 kg
7631 250'lik cotta	1,670 kg/m	14,064 m (0,586 mx24 ad)	23,49 kg
80x150 Ana Braket	3 adet	1 adet	3 adet
80x 80 Ara Braket	3 adet	1 adet	3 adet
Epil 200	2 adet	24 adet	48 adet
4,8x15 mm Geniş Kafa Pop Perçin	3x3=9 ad (Ana braket) 3x1=3 ad (Ara braket)	9 ad+3 ad	12 ad
Çelik Dübel (paslanmaz)	3x2=6 ad (Ana braket) 3x1=3 ad (Ara braket)	9 ad+3 ad	12 ad

Dış Köşe Detayı / Out Corner Detail

Dış Köşe Dönüş / Out Corner Turn

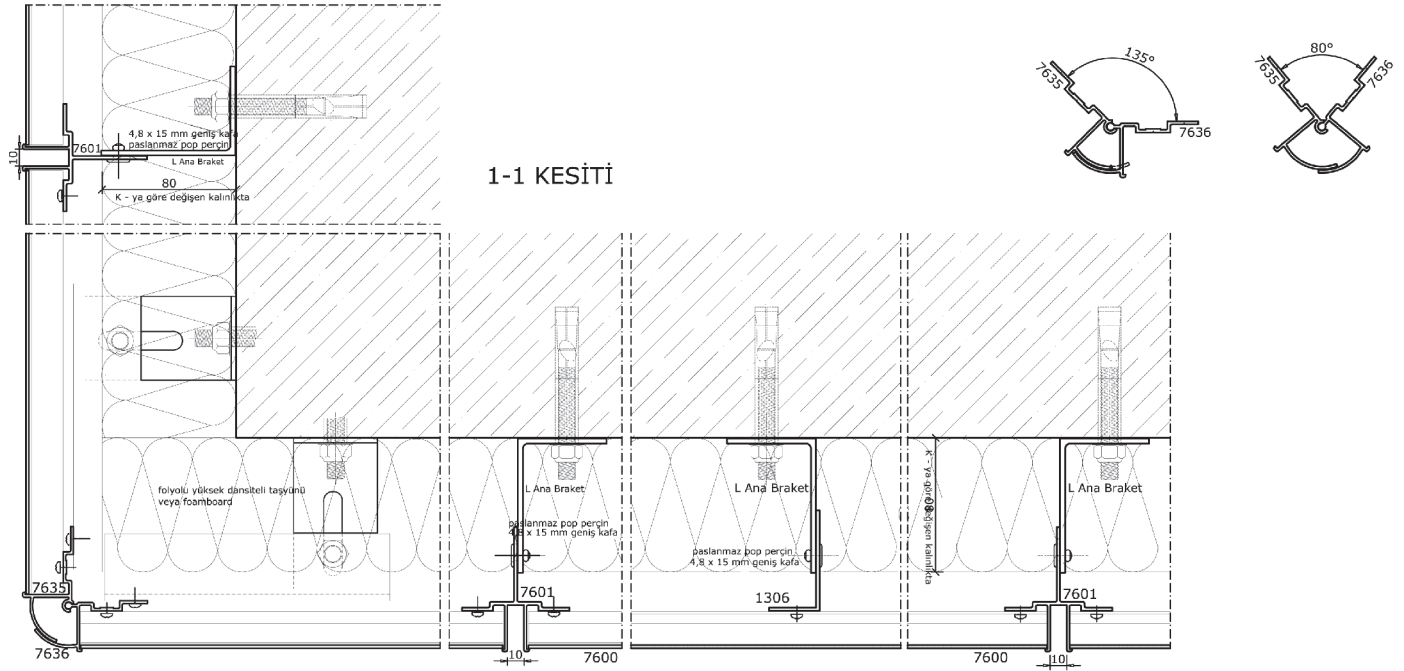

Çelik Konstrüksiyon Üzeri Montaj / Assembly to metal construction

İç Köşe Dönüş / In Corner Turn

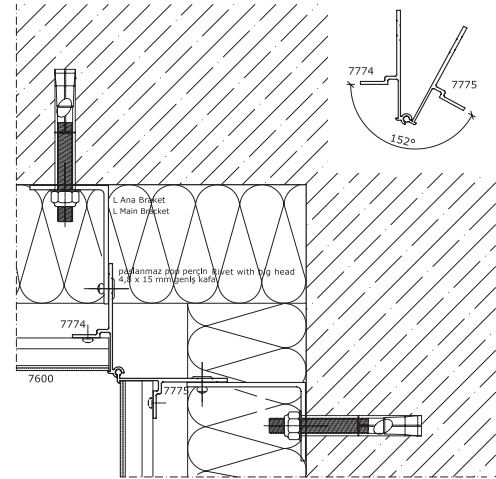
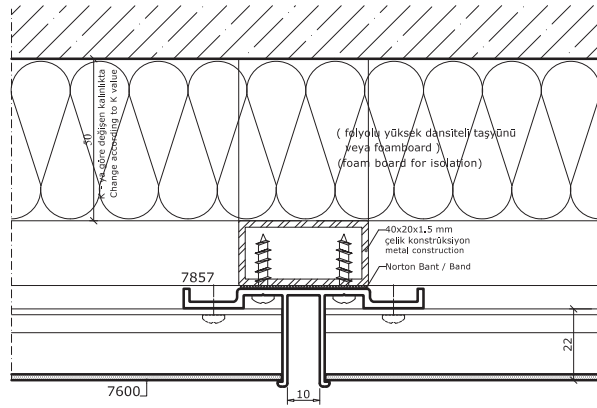

Üst Bitiş Detayı / Finished Detail

2-2 Kesiti / Side

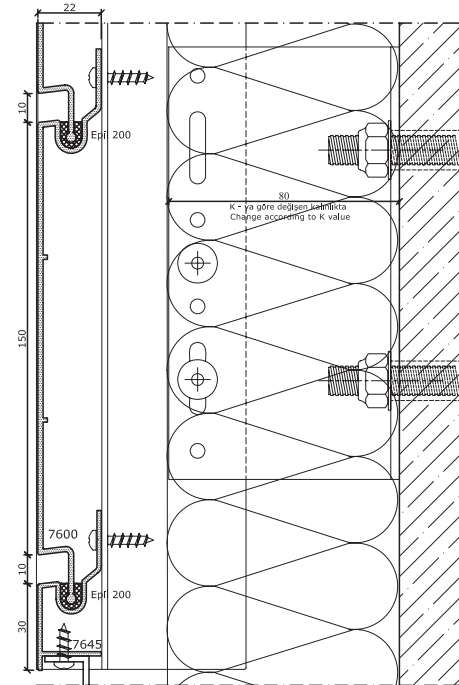
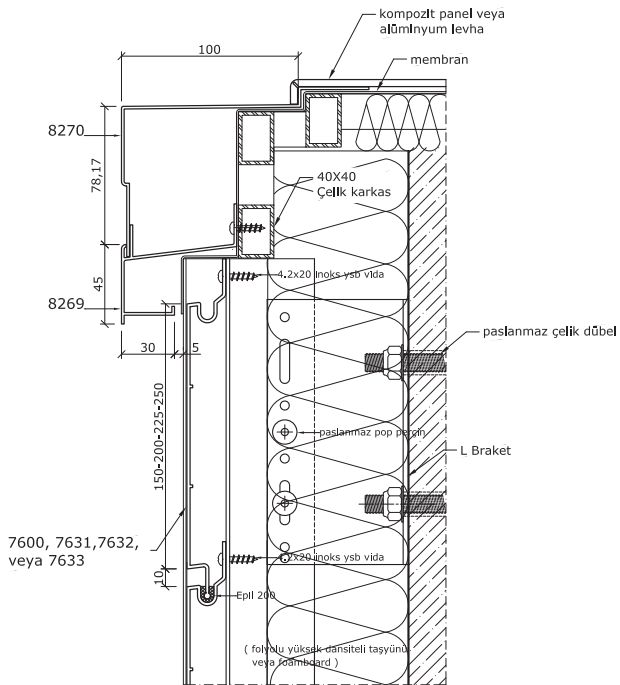

Colors Your World Timber Shades of Grey Internal Cladding Innovation Patented
First In The World! Decorative Aluminium Composite Panel Quality Approved Elegant
Saraya Linear Design Aesthetic QUALICOAT Weathered Environmentally Friendly Aluminium Siding Durable Exclusive
Saraya Cotta Design GREEN Building Colorful archITECTural Solutions Certified Solid
Aluminium Siding High Gloss Textured Perfection Antigraffiti A2 Degree External Cladding
Saraya Siding Ultra Matt Sustainability Distinctive Natural Wood Lamination Saraya Dynamic Anodized
Non Combustible Elegant Facade Ease of Assembly Ease of Assembly Dynamic Anodized
Saraya New Generation