

Pencereler  
Kapılar  
Cepheler

PVC Katalog

www.saray.com

**SARAY®**

S60 Detaylar - Details

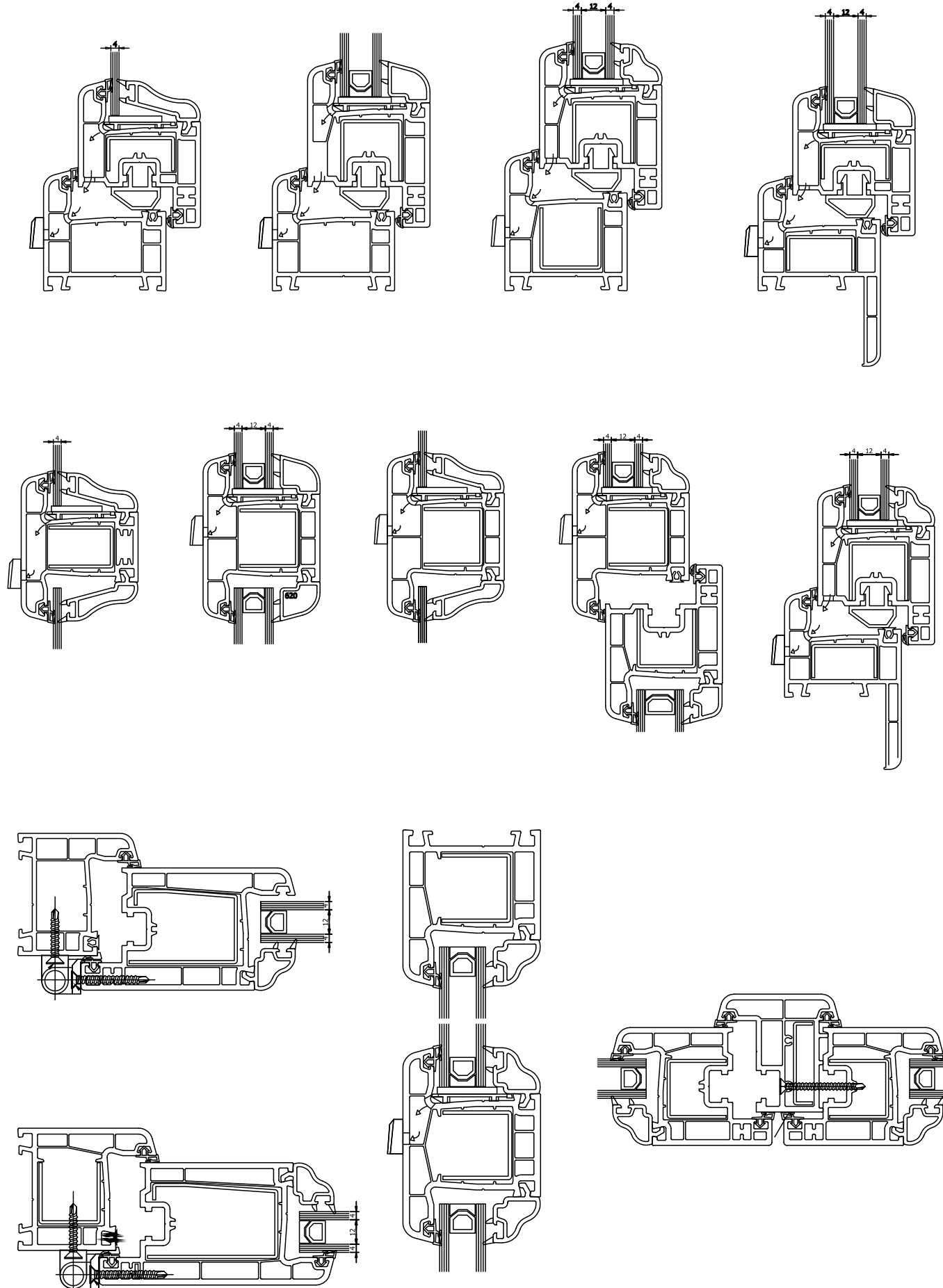

S70 Detaylar - Details

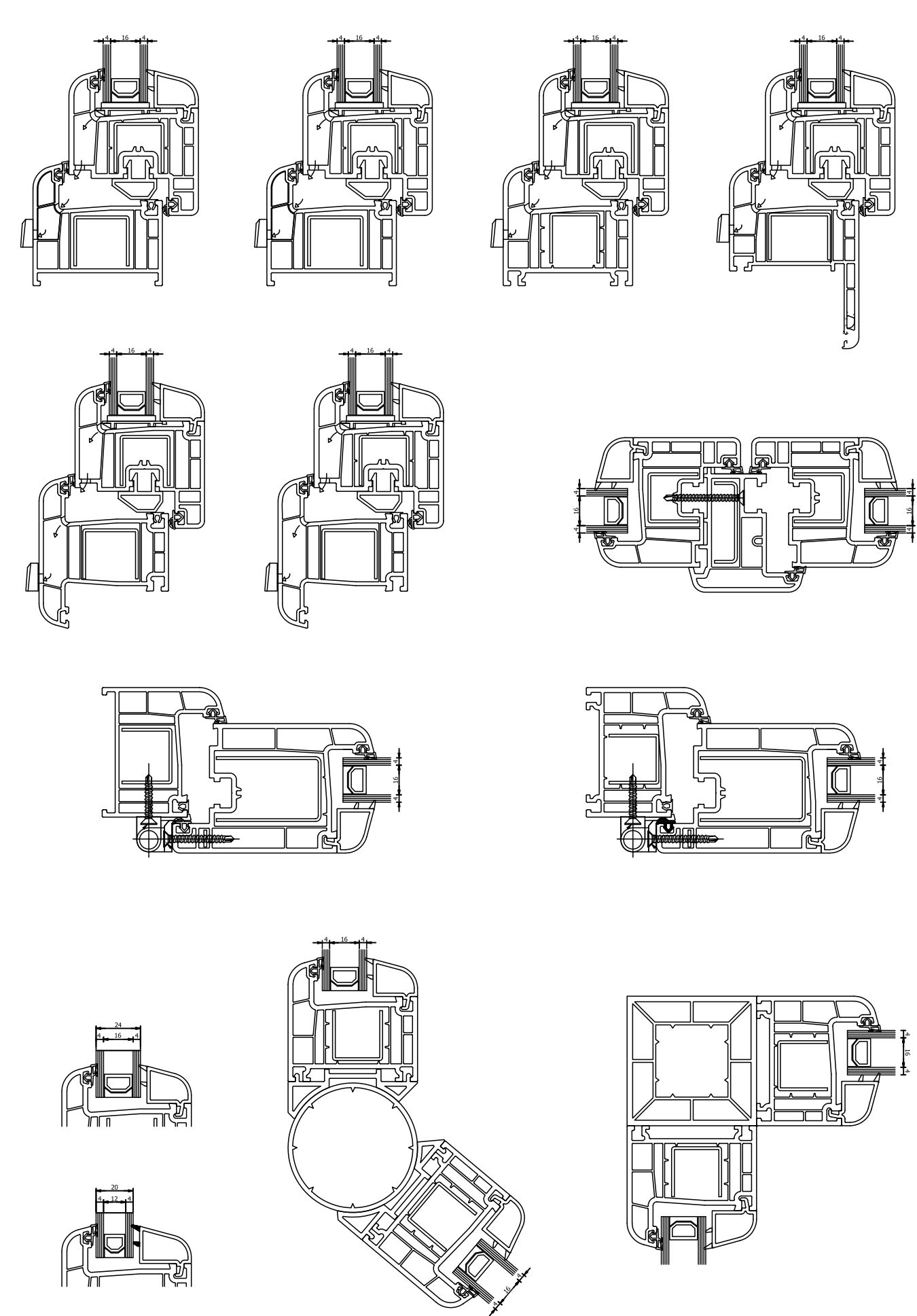

S76 Selective Detaylar - Details

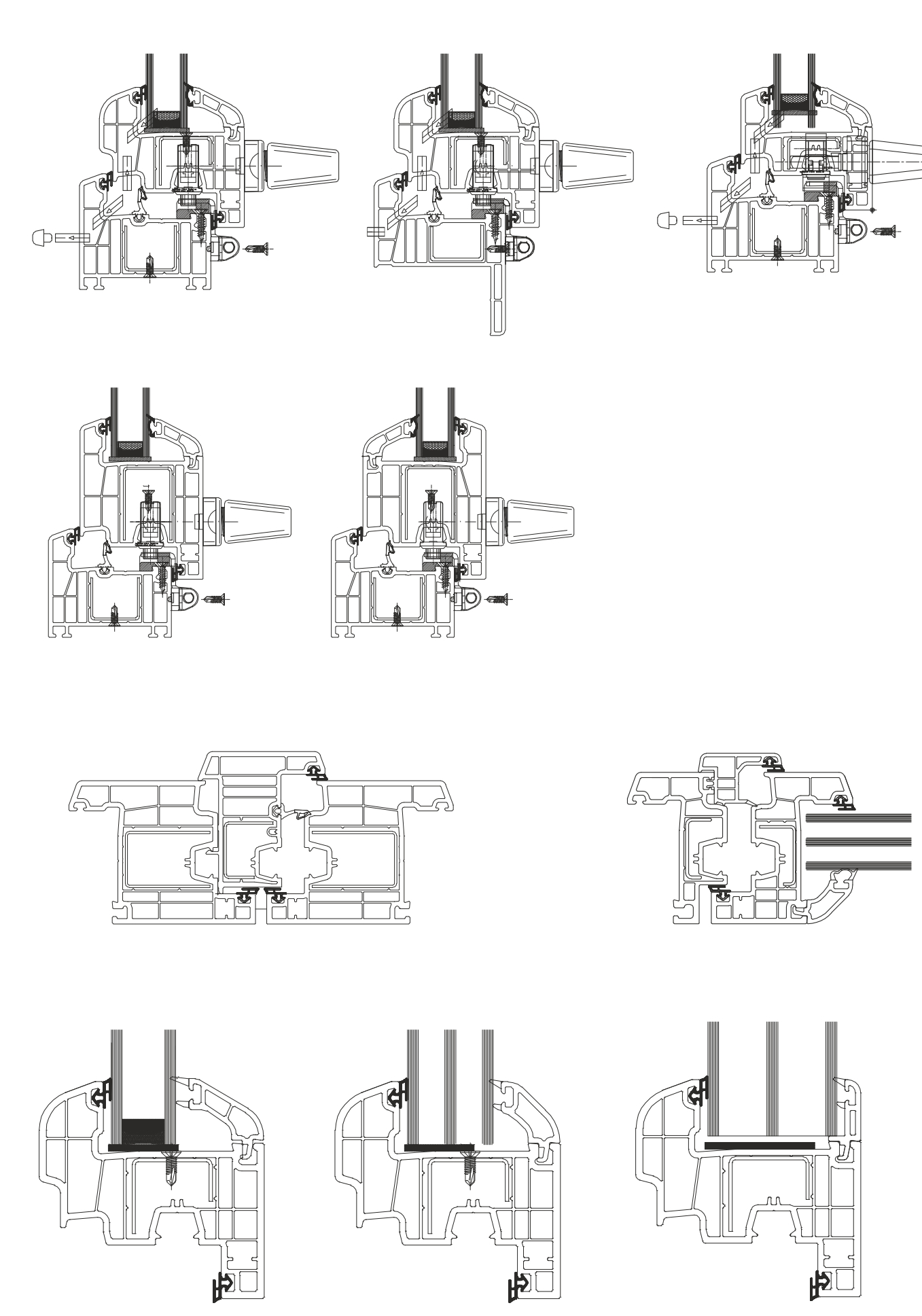

S790 Detaylar - Details

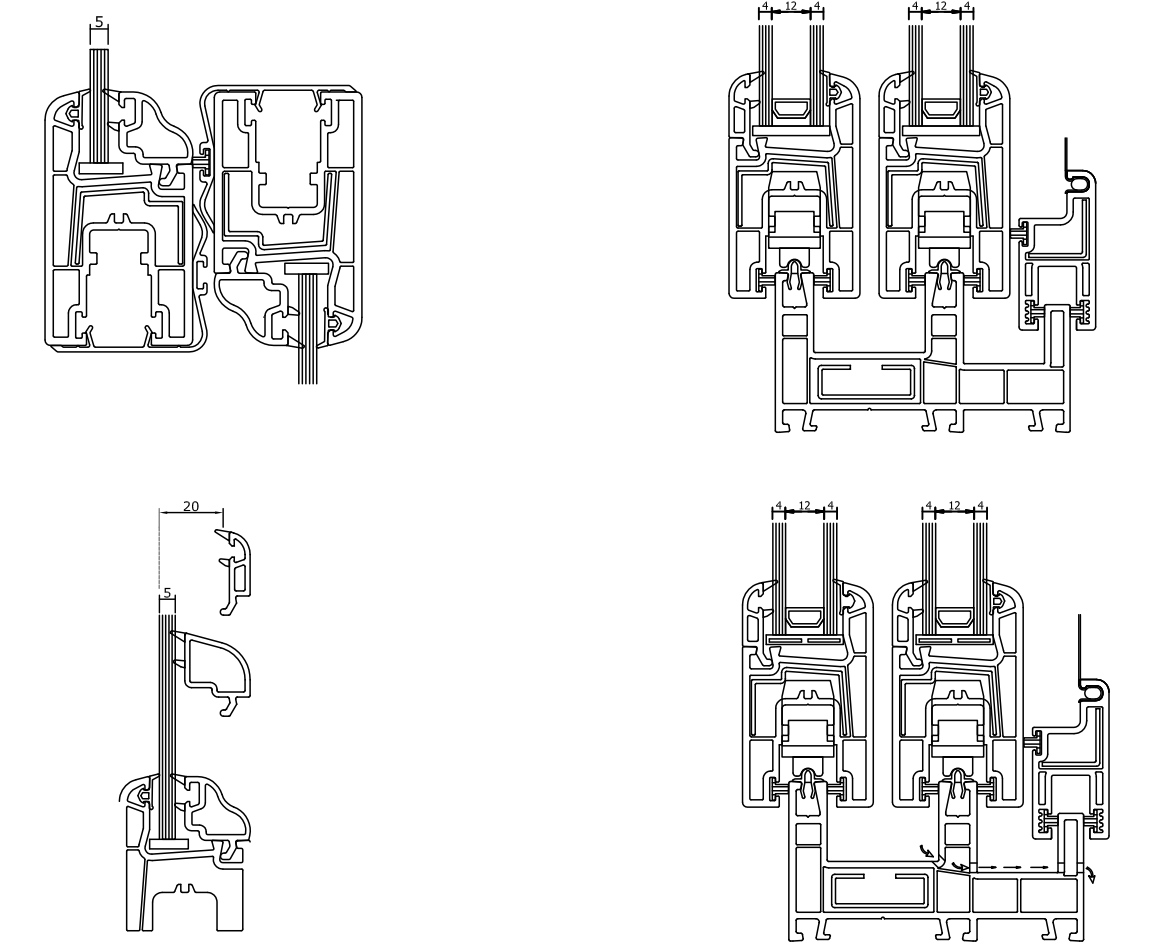

S750 Detaylar - Details

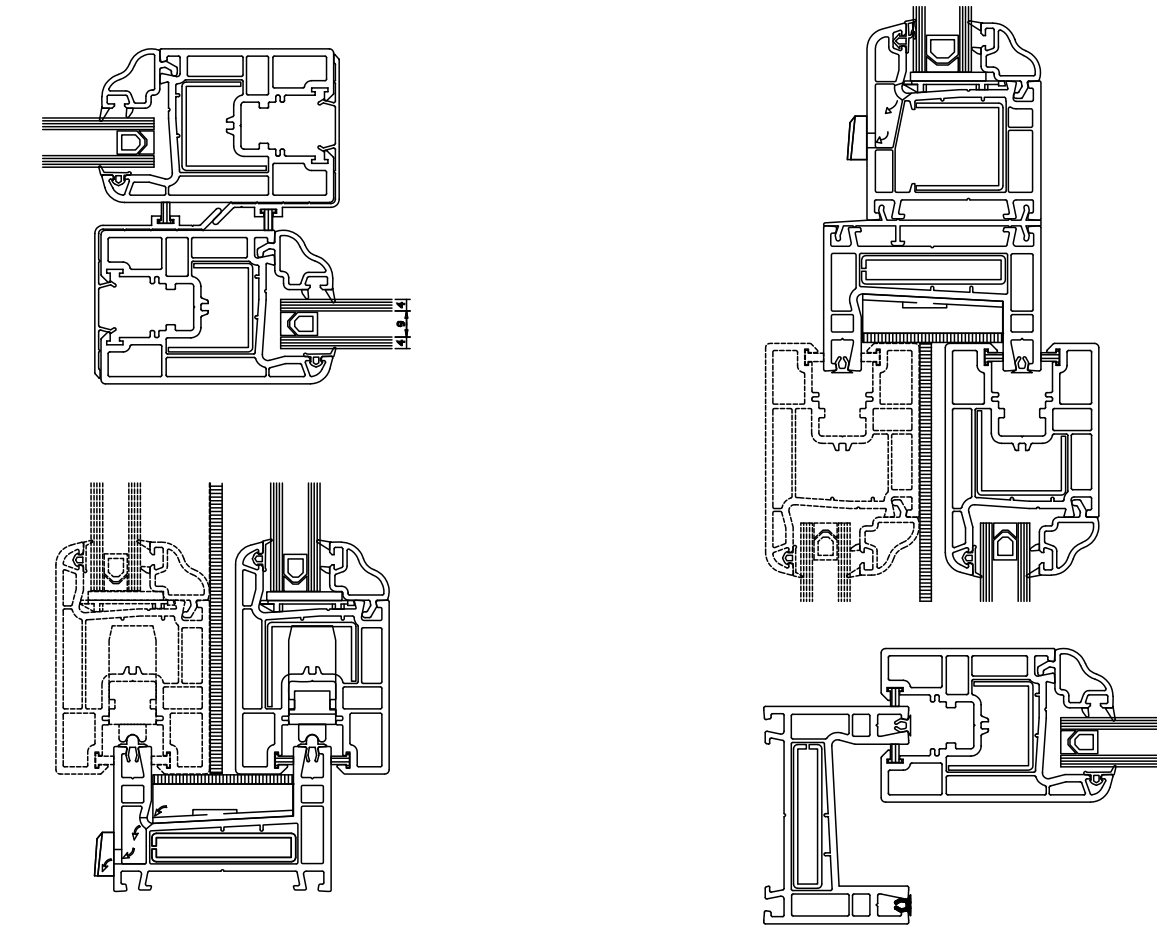

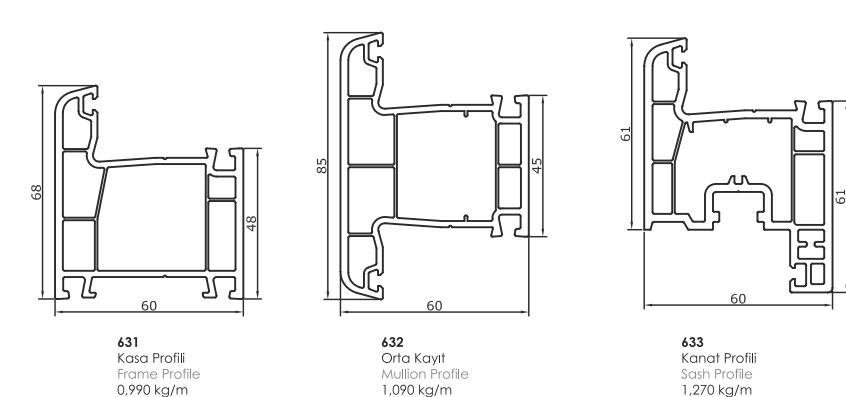

**631** Kasa Profil  
Frame Profile  
0.990 kg/m

**632** Orta Kayıt  
Mullion Profile  
1.090 kg/m

**633** Kanat Profil  
Sash Profile  
1.270 kg/m

**661** Pervazlı Kasa Profil  
Wide Frame Profile  
1.053 kg/m

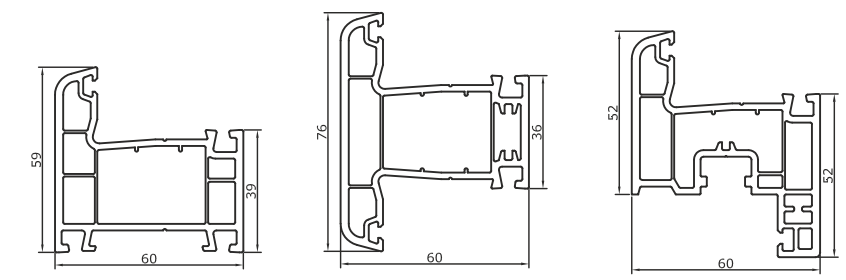

**401** Kasa Profil  
Frame Profile  
0.909 kg/m

**402** Orta Kayıt  
Mullion Profile  
1.028 kg/m

**403** Kanat Profil  
Sash Profile  
1.090 kg/m

**471** Pervazlı Kasa Profil  
Wide Frame Profile  
1.000 kg/m

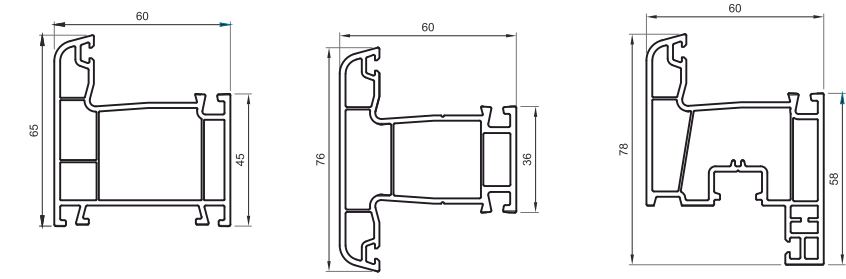

**651** Ekonomik Düz Kasa Profil  
Economic Flat Frame Profile  
0.835 kg/m

**652** Ekonomik Orta Kayıt Profil  
Economic Mullion Profile  
0.876 kg/m

**653** Ekonomik Kanat Profil  
Economic Sash Profile  
1.000 kg/m

**703** Dönme Kanat Profil  
Wide Sash Profile  
1.170 kg/m

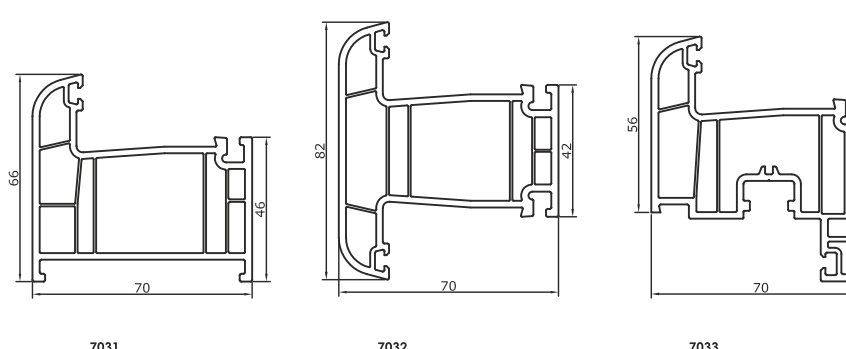

**701** Kasa Profil  
Frame Profile  
1.040 kg/m

**702** Orta Kayıt Profil  
Mullion Profile  
1.145 kg/m

**703** Kanat Profil  
Sash Profile  
1.225 kg/m

**707** Pervazlı Kanat Profil  
Wide Frame Profile  
1.222 kg/m

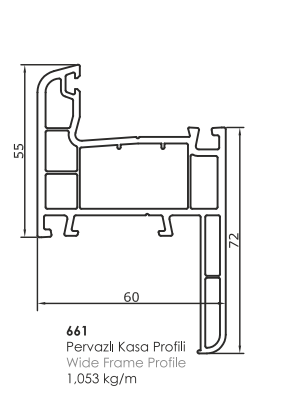

**611** 4 mm tek Cam Çıtası  
4 mm Single Glass Bead  
0.280 kg/m

**612** 20 mm çift Cam Çıtası  
20 mm Double Glass Bead  
0.180 kg/m

**621** 4 mm tek Cam Çıtası  
4 mm Single Glass Bead  
0.250 kg/m

**620** 20 mm çift Cam Çıtası  
20 mm Double Glass Bead  
0.180 kg/m

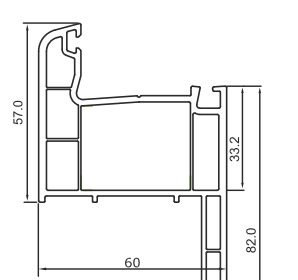

**614** 24 mm çift Cam Çıtası  
24 mm Double Glass Bead  
0.210 kg/m

**615** 34 mm çift Cam Çıtası  
34 mm Double Glass Bead  
0.140 kg/m

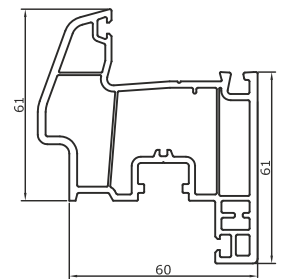

**6507** Dönme Adaptörü  
Corner Adapter  
0.210 kg/m

**6512** Kapı Altı Fırça Profil  
Door Under Brush Profile  
0.619 kg/m

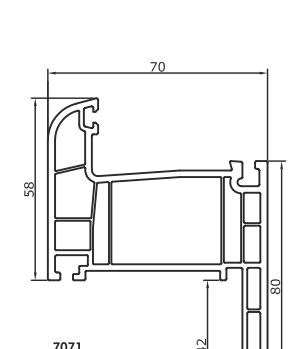

**7021** Ekstrem Dönme Bonusu  
Corner Pipe  
0.780 kg/m

**7022** Ekstrem Dönme Adaptörü  
Corner Pipe Adapter  
0.450 kg/m

**7005** Kapa Kanat Profil  
Door Sash Profile  
1.690 kg/m

**7006** Dış Açılır Kapa Kanat Profil  
Outside Opening Door Sash  
1.730 kg/m

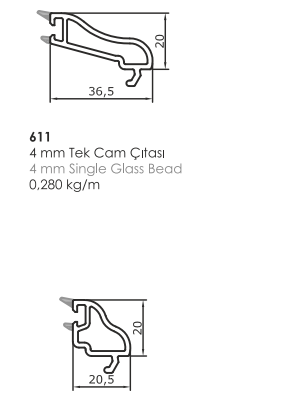

**605** Kapa Kanat Profil  
Door Sash Profile  
1.680 kg/m

**604** Hareketli Orta Kayıt  
Overhang Profile  
1.053 kg/m



**916/B** Köşe Dönme Kutu Profil  
Corner Box Profile  
1.265 kg/m (Al) / 0.750 kg/m (PVC)

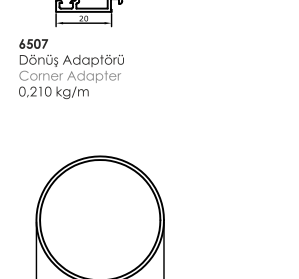

**4504** İnce Bağ Profil  
Connection Profile  
0.390 kg/m (Al) / 0.380 kg/m (PVC)

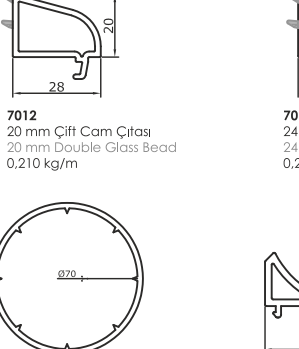

**7024** İnce Bağ Profil  
Connection Profile  
0.110 kg/m (PVC)

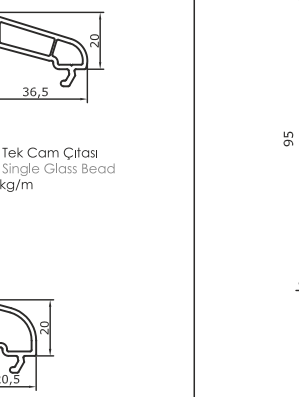

**606** Dış Açılır Kapa Profil  
Outside Opening Door Profile  
1.720 kg/m

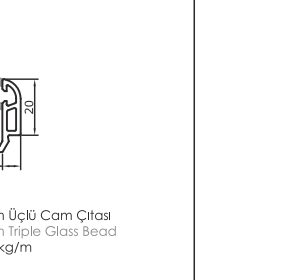

**606** Dış Açılır Kapa Profil  
Outside Opening Door Profile  
1.720 kg/m



**407** Dış Kapa Kanat Profil  
Tight Door Sash Profile  
1.485 kg/m

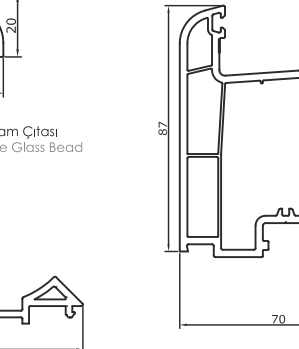

**7025** Köşe Dönme Kutu Profil  
Corner Box Profile  
1.500 kg/m

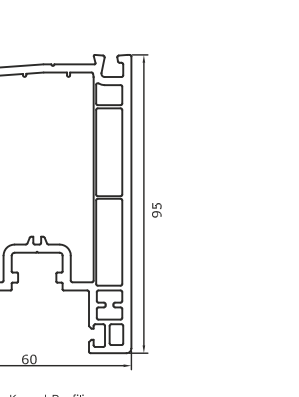

**606** Dış Açılır Kapa Profil  
Outside Opening Door Profile  
1.720 kg/m

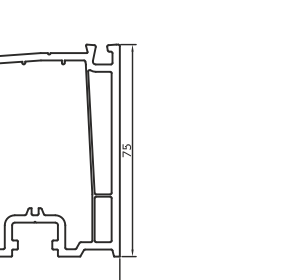

**606** Dış Açılır Kapa Profil  
Outside Opening Door Profile  
1.720 kg/m

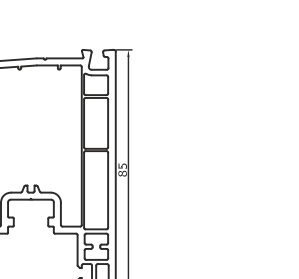

**407** Dış Kapa Kanat Profil  
Tight Door Sash Profile  
1.485 kg/m

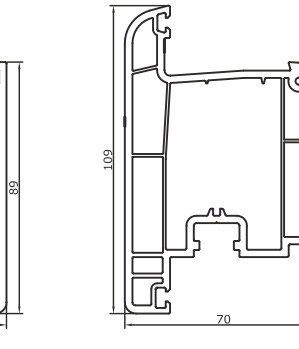

**7025** Köşe Dönme Kutu Profil  
Corner Box Profile  
1.500 kg/m

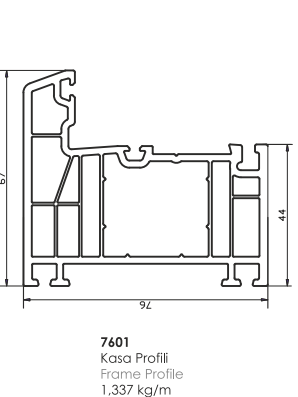

**7401** Kasa Profil  
Frame Profile  
1.337 kg/m

**7409** Pervazlı Kasa Profil  
Wide Frame Profile  
1.375 kg/m

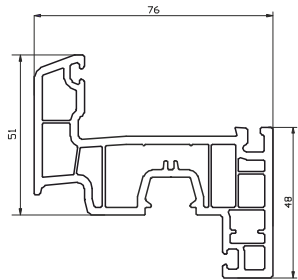

**7404** Dar Kanat Profil  
Tight Sash Profile  
1.334 kg/m

**7411** Hareketli Orta Kayıt Profil  
Overhang Profile  
1.256 kg/m

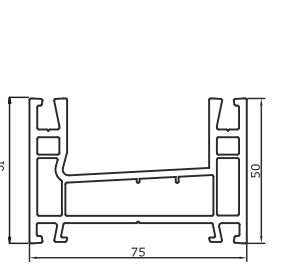

**751** Sürme Kasa  
Sliding Frame  
1.250 kg/m

**754** Pervazlı Sürme Kasa  
Wide Sliding Frame  
1.170 kg/m

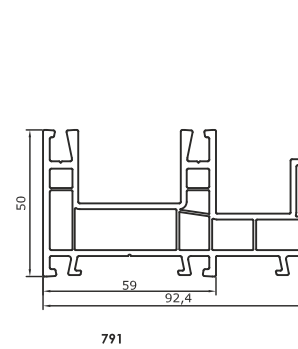

**791** Sürme Sinekli Kasa  
3 Track Sliding Frame Profile  
1.310 kg/m

**793** Sürme Kanat  
Sliding Sash Profile  
0.935 kg/m

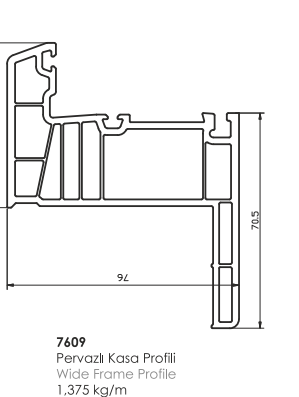

**7402** Orta Kayıt Profil  
Mullion Frame Profile  
1.410 kg/m

**7403** Kapa Kanat Profil  
Door Sash Profile  
1.480 kg/m

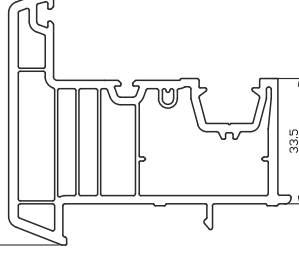

**7410** Dar Hareketli Orta Kayıt Profil  
Tight Overhang Profile  
1.056 kg/m

**7412** Sürme Ekonomik Kanat  
Sliding Sweater Sash  
1.1151 kg/m

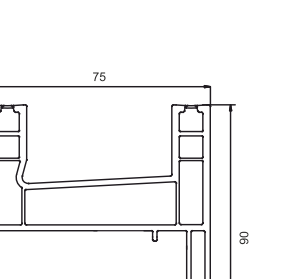

**755** Sürme Fiks Kasa  
Fix Sliding Frame  
1.540 kg/m

**757** Sürme Ekonomik Kanat  
Sliding Sweater Sash  
1.1151 kg/m

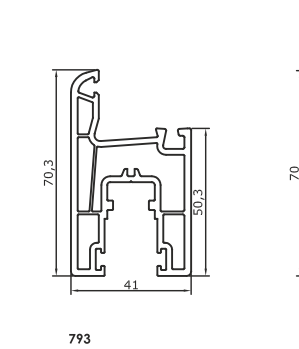

**792** Sürme Orta Kayıt  
Sliding Mullion  
0.715 kg/m

**795** Sürme Sinekli Kanat  
Sliding Sweater Sash Profile  
0.310 kg/m

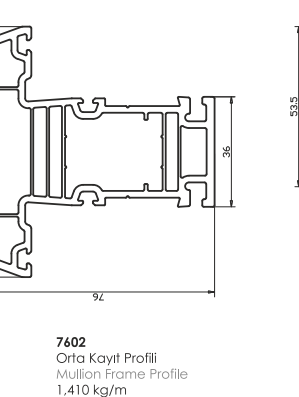

**7603** Kapa Kanat Profil  
Door Sash Profile  
1.480 kg/m

**7605** Dış Açılır Kapa Profil  
Outside Opening Door Profile  
1.760 kg/m

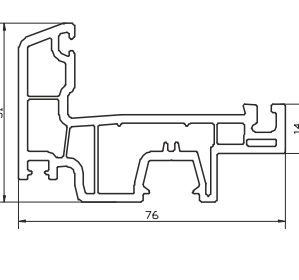

**7602** Orta Kayıt Profil  
Mullion Frame Profile  
1.410 kg/m

**7604** Dar Kanat Profil  
Tight Sash Profile  
1.334 kg/m

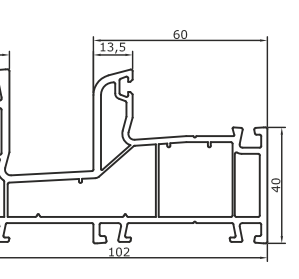

**752** Sürme Kanat  
Sliding Sweater Sash  
0.638 kg/m

**753** Sürme Orta Kayıt  
Sliding Mullion  
0.890 kg/m

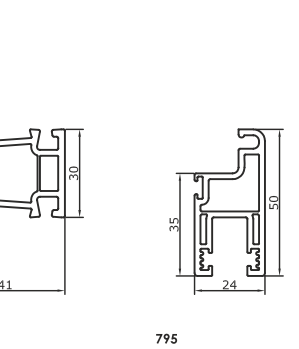

**794** Sürme Sinekli Orta Kayıt  
Sliding Sweater Mullion Profile  
0.369 kg/m

**794 (4518)** Sürme Kanatı Kapama (İnterlok)  
Interlock Profile  
0.380 kg/m

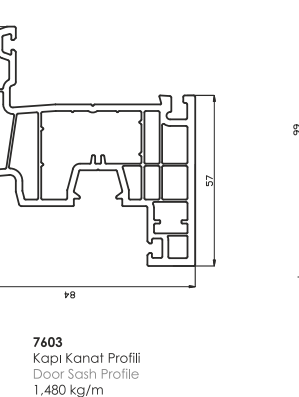

**7607** 24 mm Cam Çıtası  
24 mm Glass Bead  
0.248 kg/m

**7608** 32 mm Cam Çıtası  
32 mm Glass Bead  
0.238 kg/m

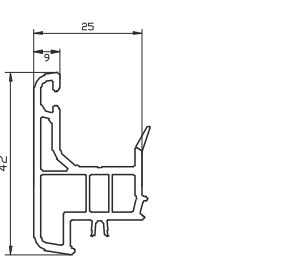

**7613** 48 mm Cam Çıtası  
48 mm Glass Bead  
0.178 kg/m

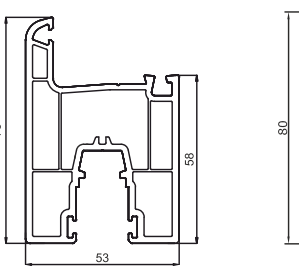

**758** Pervazlı Sinekli Kasa  
Sliding Frame  
1.860 kg/m

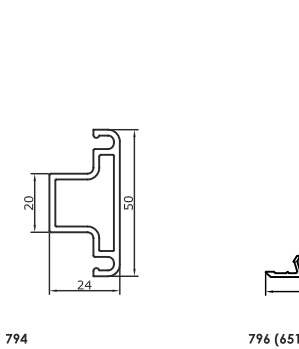

**801** Pervazlı Sürme Kasa  
Wide Sliding Frame  
1.400 kg/m

**802** Sürme Kasa  
Sliding Frame  
1.330 kg/m

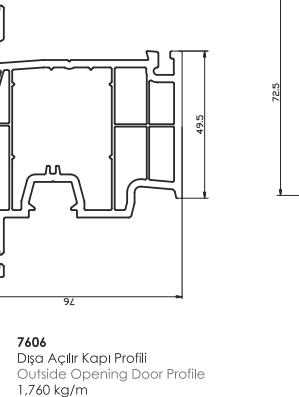

**7605** Dış Açılır Kapa Profil  
Outside Opening Door Profile  
1.762 kg/m

**7602** Orta Kayıt Profil  
Mullion Frame Profile  
1.410 kg/m



**7610** Dar Hareketli Orta Kayıt Profil  
Tight Overhang Profile  
1.056 kg/m

**7612** Sürme Ekonomik Kanat  
Sliding Sweater Sash  
1.1151 kg/m

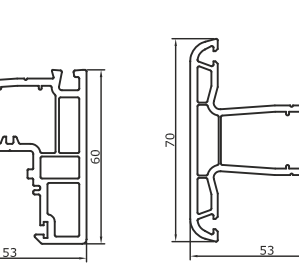

**752** Sürme Kanat  
Sliding Sweater Sash  
0.638 kg/m

**753** Sürme Orta Kayıt  
Sliding Mullion  
0.890 kg/m

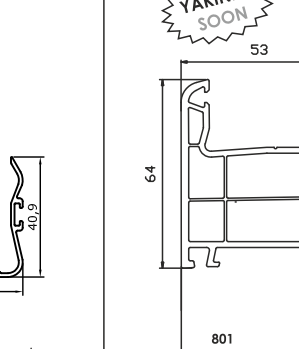

**801** Pervazlı Sürme Kasa  
Wide Sliding Frame  
1.400 kg/m

**802** Sürme Kasa  
Sliding Frame  
1.330 kg/m

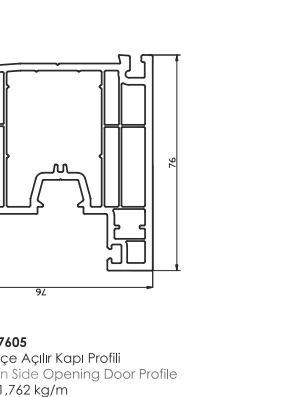

**7605** Dış Açılır Kapa Profil  
Outside Opening Door Profile  
1.762 kg/m

**7602** Orta Kayıt Profil  
Mullion Frame Profile  
1.410 kg/m



**7610** Dar Hareketli Orta Kayıt Profil  
Tight Overhang Profile  
1.056 kg/m

**7612** Sürme Ekonomik Kanat  
Sliding Sweater Sash  
1.1151 kg/m

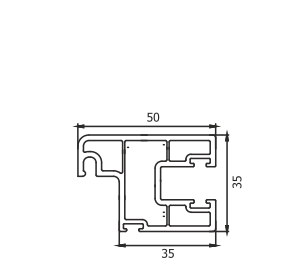

**752** Sürme Kanat  
Sliding Sweater Sash  
0.638 kg/m

**753** Sürme Orta Kayıt  
Sliding Mullion  
0.890 kg/m

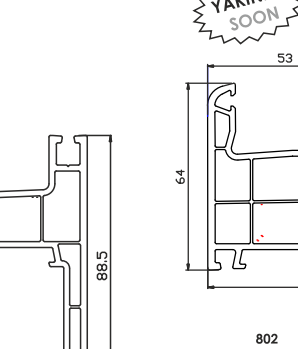

**801** Pervazlı Sürme Kasa  
Wide Sliding Frame  
1.400 kg/m

**802** Sürme Kasa  
Sliding Frame  
1.330 kg/m

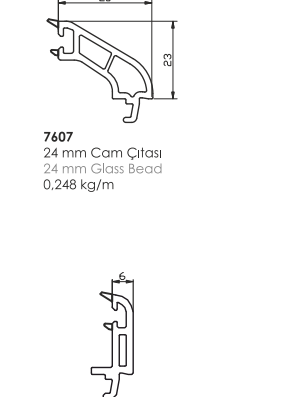

**7605** Dış Açılır Kapa Profil  
Outside Opening Door Profile  
1.762 kg/m

**7602** Orta Kayıt Profil  
Mullion Frame Profile  
1.410 kg/m



**7610** Dar Hareketli Orta Kayıt Profil  
Tight Overhang Profile  
1.056 kg/m

**7612** Sürme Ekonomik Kanat  
Sliding Sweater Sash  
1.1151 kg/m

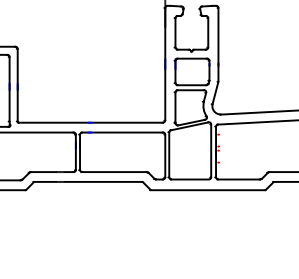

**752** Sürme Kanat  
Sliding Sweater Sash  
0.638 kg/m

**753** Sürme Orta Kayıt  
Sliding Mullion  
0.890 kg/m

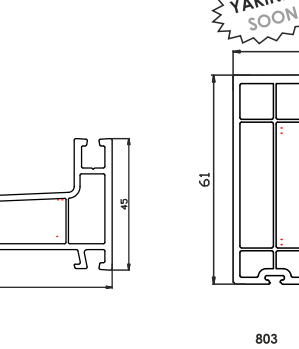

**801** Pervazlı Sürme Kasa  
Wide Sliding Frame  
1.400 kg/m

**802** Sürme Kasa  
Sliding Frame  
1.330 kg/m

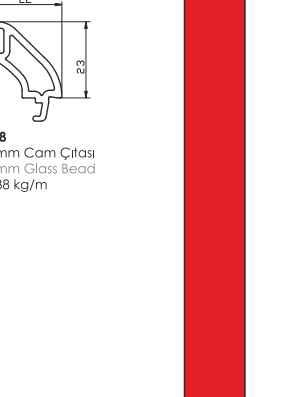

**7605** Dış Açılır Kapa Profil  
Outside Opening Door Profile  
1.762 kg/m

**7602** Orta Kayıt Profil  
Mullion Frame Profile  
1.410 kg/m

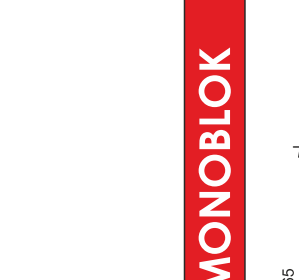

**7610** Dar Hareketli Orta Kayıt Profil  
Tight Overhang Profile  
1.056 kg/m

**7612** Sürme Ekonomik Kanat  
Sliding Sweater Sash  
1.1151 kg/m

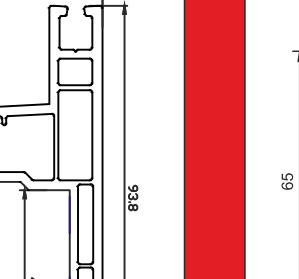

**752** Sürme Kanat  
Sliding Sweater Sash  
0.638 kg/m

**753** Sürme Orta Kayıt  
Sliding Mullion  
0.890 kg/m

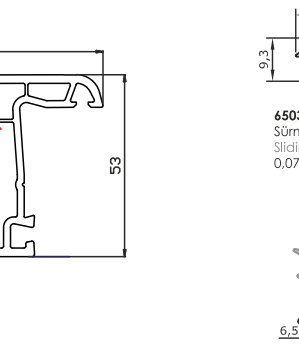

**801** Pervazlı Sürme Kasa  
Wide Sliding Frame  
1.400 kg/m

**802** Sürme Kasa  
Sliding Frame  
1.330 kg/m

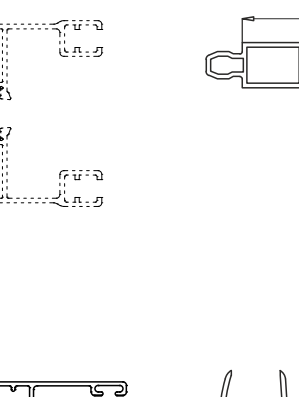

**7605** Dış Açılır Kapa Profil  
Outside Opening Door Profile  
1.762 kg/m

**7602** Orta Kayıt Profil  
Mullion Frame Profile  
1.410 kg/m

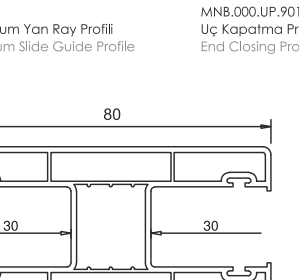

**7610** Dar Hareketli Orta Kayıt Profil  
Tight Overhang Profile  
1.056 kg/m

**7612** Sürme Ekonomik Kanat  
Sliding Sweater Sash  
1.1151 kg/m

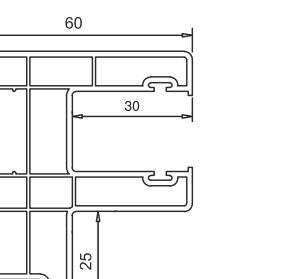

**752** Sürme Kanat  
Sliding Sweater Sash  
0.638 kg/m

**753** Sürme Orta Kayıt  
Sliding Mullion  
0.890 kg/m

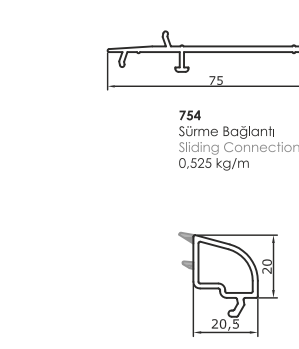

**801** Pervazlı Sürme Kasa  
Wide Sliding Frame  
1.400 kg/m

**802** Sürme Kasa  
Sliding Frame  
1.330 kg/m

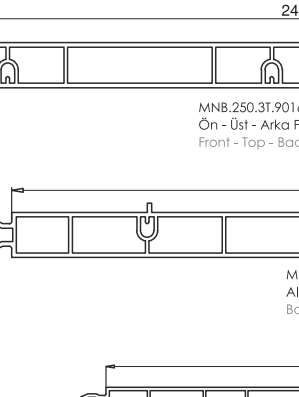

**7605** Dış Açılır Kapa Profil  
Outside Opening Door Profile  
1.762 kg/m

**7602** Orta Kayıt Profil  
Mullion Frame Profile  
1.410 kg/m

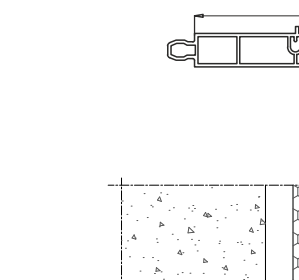

**7610** Dar Hareketli Orta Kayıt Profil  
Tight Overhang Profile  
1.056 kg/m

**7612** Sürme Ekonomik Kanat  
Sliding Sweater Sash  
1.1151 kg/m

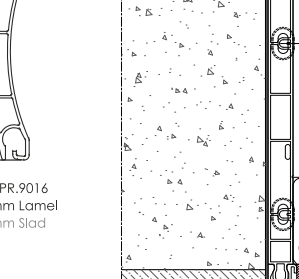

**752** Sürme Kanat  
Sliding Sweater Sash  
0.638 kg/m

**753** Sürme Orta Kayıt  
Sliding Mullion  
0.890 kg/m

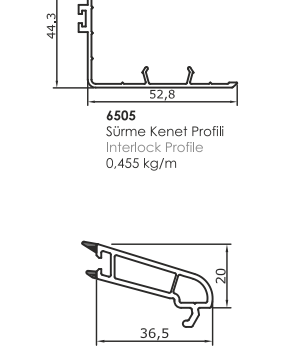

**801** Pervazlı Sürme Kasa  
Wide Sliding Frame  
1.400 kg/m

**802** Sürme Kasa  
Sliding Frame  
1.330 kg/m

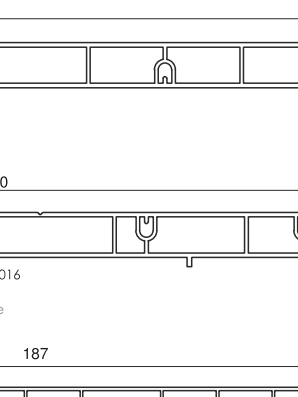

**7605** Dış Açılır Kapa Profil  
Outside Opening Door Profile  
1.762 kg/m

**7602** Orta Kayıt Profil  
Mullion Frame Profile  
1.410 kg/m

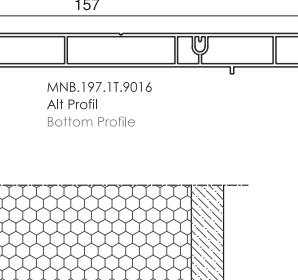

**7610** Dar Hareketli Orta Kayıt Profil  
Tight Overhang Profile  
1.056 kg/m

**7612** Sürme Ekonomik Kanat  
Sliding Sweater Sash  
1.1151 kg/m

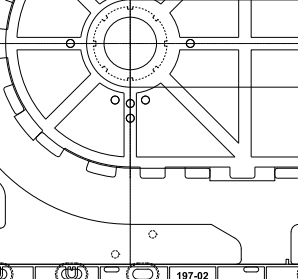

**752** Sürme Kanat  
Sliding Sweater Sash  
0.638 kg/m

**753** Sürme Orta Kayıt  
Sliding Mullion  
0.890 kg/m

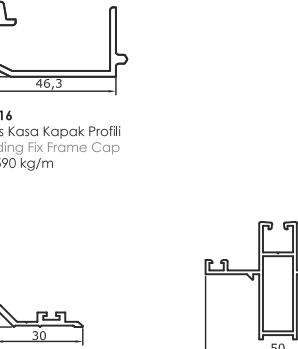

**801** Pervazlı Sürme Kasa  
Wide Sliding Frame  
1.400 kg/m

**802** Sürme Kasa  
Sliding Frame  
1.330 kg/m

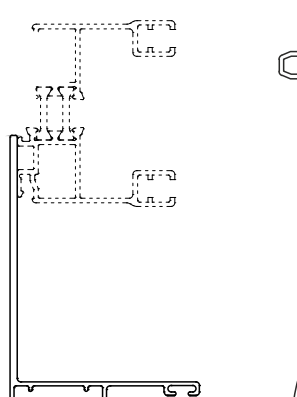

**14005** Alüminyum Yan Ray Profil  
Aluminum Side Guide Profile

**MNB.000.UP.9016** Üç Kapama Profil  
End Closing Profile

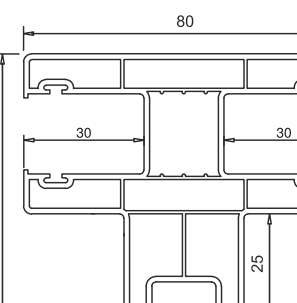

**MNB.250.3T.9014** Ön - Üst - Arka Profil  
Front - Top - Back Profile

**MNB.250.1T.9016** Alt Profil  
Bottom Profile

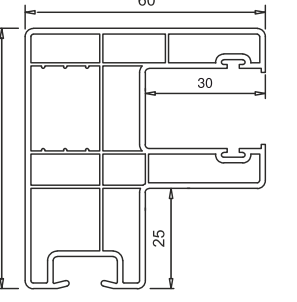

**MNB.197.3T.9016** Üç Kapama Profil  
Front - Top - Back Profile

**MNB.197.1T.9016** Alt Profil  
Bottom Profile

